



2025

QUICK REFERENCE GUIDE FOR FLORIDA TRAFFIC LAWS

This document serves as an abbreviated guide. It is recommended that you reference your Florida State Statute book for further clarification and changes.

TABLE OF CONTENTS

Table of Contents	1
Most Commonly Used FSS	2
ATV	3
Bicycle Regulations	3 - 5
Bumper Laws	5
Careless Driving	6
Crashes	6
Distracted Driving	6
Driver License / ID Cards	7 - 14
DUI / Alcohol	15
Equipment	16
Headlights	17
Insurance	17
Lane	17 - 19
Lights (Vehicle)	19 - 20
Miscellaneous	20 - 22
Motorcycles / Mopeds	22 - 23
Move Over	24
Parking	24 - 25
Passing	25 - 26
Pedestrian	26 - 28
Racing	28
Safety Belts & Child Restraints	29
Speeding	30
Tag / Registration	31
Traffic Control Devices	32
Turning	33
Yield Right of Way	33 - 34
Window Tint	34
Abbreviations State / Territory	35
Commercial Motor Vehicles	36 - 41
Property Damage Estimates	42 - 43
Bicycles and Other Pedestrian Vehicles Chart	44 - 45
Motorcycles and Other Non-traditional Vehicles Chart	46 - 47
Traffic Safety Coalitions	48
Aging Road User Resources	49
Website / Phone Number Resources	50
Notes	51 - 52

Most Commonly Used FSS

Criminal Violations

DUI/Alcohol	316.193 (1)
Reckless driving	316.192 (1)
Reckless Driving-Property damage or injury	316.192 (3) (c) (1)
Leaving scene of crash-Property damage	316.061 (1)
Leaving Scene of crash-Injury or death	316.027 (2)
Racing on highway-driving	316.191 (2) (a)
No/improper/expired/DL	322.03 (1)
Possession blank/forged Stolen DL	322.212 (1) (a)
DL- Cancelled/suspended/revoked	322.32 (2)(a)
Tag-None/fail to register	320.02 (1)
Tag-Expired < 6mo (2nd or Sub Offense)	320.07 (3) (c)

Moving Offenses

Unlawful Speed	316.183 (2)
Posted Speed-Work Zone	316.183 (6)
School Zone	316.1895 (10)
Municipal Road	316.189 (1)
County Road	316.189 (2)
State Road	316.187 (1)
Careless Driving	316.1925 (1)
Drive While DL Susp/Can/Rev W/O Know	322.34 (1)
Fail To Yield	
At intersection	316.121 (1)
ROW-Unmarked intersection	316.121 (3)
ROW-Frm Alley At Sidewalk/drive/bld – to vehicles	316.125 (1)
ROW-Frm Alley At Sidewalk/drive/bld – to pedestrians	316.125 (2)
Fail To Yield- Emergency Vehicle	316.126 (1) (a)
Fail To Yield- Blind Pedestrian	316.1301 (2)
Move Over	
Vacate lane	316.126 (1) (b) 1
20mph<posted speed	316.126 (1) (b) 2
Fail to Stop	
School bus	316.172 (1) (a)
Stop sign	316.123 (2) (a)
Steady red light	316.075 (1) (c) 1
Flashing red light	316.076 (1) (a)
Improper Pass	
Left approach vehicle	316.082 (1)
Bicycle, minimum 3 feet	316.083 (2)
Bicycle, minimum 3 feet in a bicycle lane	316.083 (3)
Signal required	316.083 (1)
Yield ROW to overtaking vehicle	316.083 (5)
Infant-3 years of age child restraint	316.613 (1) (a) 1
Child 4-5 years of age	316.613 (1) (a) 2

Non-Moving Offenses

TAG	
Expired (6 months or less)	320.07 (3) (a)
Expired (>6 months, 1st offense)	320.07 (3) (b)
Improper display of tag	316.605 (1)
DL	
Expired less than 6 months	322.065
Fail to display	322.15 (1)
Proof of insurance required	316.646 (1)
Seatbelt Violation	
Driver	316.614 (4) (b)
Front passenger (Over 18 years of age)	316.614 (5)
Anyone under 18 years of age (Driver Cited)	316.614 (4) (a)
Improper/faulty/unsafe equipment	316.610

ATV

All-Terrain Vehicles (ATV) operators UNDER 16 years old MUST wear helmet and eye protection	316.2074 (3)	Non-moving
Failure to give notice of ATV crash involving injury or death	316.2074 (4)	Non-moving
Improper operation on public roads, streets or highways	316.2074 (5)	Non-moving

BICYCLE REGULATIONS

Cyclist Violations

Bicycle on limited access facilities, interstate highways	316.091 (4)	Moving
Not signaling intent to turn	316.155	Moving
Improper hand signal	316.157 (1) (a) – (c)	Moving
DUI - Bicycle	316.193 (1)	Criminal
Possession of open container (driver) when operating vehicle	316.1936 (2) (a)	Moving
All persons propelling vehicle by human power has same rights and duties of any other vehicle	316.2065 (1)	Bicycle
Seat, not permanent or regular	316.2065 (2)	Bicycle
Riding more persons than bike is designed for	316.2065 (3) (a)	Bicycle
Seat requirements for carrying child passenger = <40lbs or <4 years of age	316.2065 (3) (b)	Bicycle
Child left in child seat on bicycle unattended	316.2065 (3) (c)	Bicycle
Helmet required if under 16 years old (rider or passenger)	316.2065 (3) (d)	Bicycle
Riding on roadway while attached to another vehicle	316.2065 (4)	Bicycle

BICYCLE REGULATIONS

Continued

Failure to ride close to the right hand curb (Impede traffic flow) Exceptions: <ul style="list-style-type: none">• Passing another bicycle or vehicle proceeding in the same direction• Preparing for a left turn• When necessary to avoid a conflict	316.2065 (5) (a)	Bicycle
Bicycling more than two abreast	316.2065 (6) (a)	Bicycle
Lights and reflectors required between sunset to sunrise; white light (visible from 500 feet) on front; red light on rear (visible from 600 feet)	316.2065 (7)	Bicycle
Parent/Guardian allowing minor to violate bicycle regulations	316.2065 (8)	Bicycle
All persons propelling vehicle by human power on crosswalk/sidewalk has same rights and duties of a pedestrian	316.2065 (9)	Bicycle
Not yielding or audibly signaling before overtaking a pedestrian	316.2065 (10)	Bicycle
Bicycle regulations do not apply when street has been designated as a play street (Permitted Street Closure)	316.2065 (12)	Bicycle
Retail sale of bicycle w/o identifying number	316.2065 (14)	Bicycle
May not rent/lease bicycle to person under 16 years of age without helmet	316.2065 (15) (a)	Non-moving
Wearing headset, headphone, or another device when driving	316.304 (1)	Bicycle
No roller skates, or similar device(s) on roadway	316.2065 (11)	Bicycle
No brakes on bicycle	316.2065 (13)	Bicycle

Vehicle Violations

Failure to Yield - at traffic signal	316.075	Moving
Failure to allow 3 feet for bicycle in the travel lane	316.083 (2)	Moving
Failure to allow 3 feet for bicycle in the bike lane	316.083 (3)	Moving
Failure to Yield - yield or stop sign	316.123	Moving
Failure to Yield – alley, building, private road, or driveway	316.125	Moving
Failure to Yield - at crosswalk	316.130 (7)	Moving
A vehicle may not overtake a stopped vehicle that is allowing pedestrian in crosswalk to cross	316.130 (9)	Moving
Not using due care near bicyclist / pedestrian	316.130 (15)	Moving
Vehicles are required to stop if a person with guide dog or using an extended white/red tip cane is crossing the roadway	316.1301 (2)	Moving
Driving on sidewalk / bike path	316.1995	Moving
Obstructing crosswalk	316.2061	Moving

BUMPER LAWS

<ul style="list-style-type: none"> • Cars Less than 2,500 lbs. Max: Front 22" Rear 22" • Cars 2,500 to 3,500 lbs. Max: Front 24" Rear 26" • Cars 3,500 lbs. or more Max: Front 27" Rear 29" 	316.251 (1)	Moving
<ul style="list-style-type: none"> • Trucks Less than 2,000 lbs. Max: Front 24" Rear 26" • Trucks 2,000 to 3,000 lbs. Max: Front 27" Rear 29" • Trucks 3,000 to 5,000 lbs. Max: Front 28" Rear 30" 	316.251 (1)	Moving

CARELESS DRIVING

Careless Driving	316.1925 (1)	Moving
------------------	--------------	--------

Mark “**Aggressive Careless Driving**” (316.1923) if two or more of the following were committed simultaneously or in succession:

- Exceeding the posted speed
- Unsafely or improperly changing lanes
- Following too closely
- Failure to yield the right of way
- Improper passing
- Violating traffic control device and / or signals

CRASHES

Leaving the scene - Injury or death	316.027 (2)	Criminal FELONY
Leaving the scene - Property damage	316.061 (1)	Criminal
Failure to remove damaged vehicle obstructing traffic after crash	316.061 (2)	Non-moving
Failure to immediately report crash by	316.065 (1)	Non-moving
Insurance - no proof at crash	316.066 (1) (d)	Non-moving
Giving false information	316.067	Criminal

DISTRACTED DRIVING

Texting while driving (1 st violation)	316.305 (4) (a)	Non-moving
Texting while driving (2 nd or subsequent violation)	316.305 (4) (b)	Moving
Using a wireless communications device in a handheld manner in a designated school crossing, school zone, or work zone	316.306 (3) (a) 1	Moving

DRIVER LICENSE / ID CARDS

Failure to sign citation (Only for Criminal UTC and infraction requiring a court date)	318.14 (3)	Criminal
No Driver License (DL) * Never had one issued	322.03 (1)	Criminal
Failure to surrender CDL	322.03 (2) (a)	Moving
Can't possess more than one valid FL DL at any time	322.03 (2) (b)	Criminal
Driving motorcycle without a motorcycle endorsement	322.03 (5)	Criminal
Expired DL more than 6 months	322.03 (6)	Criminal
FL DL required within 30 days of accepting employment or registering child in school	322.031 (1)	Criminal
Cannot operate a motor vehicle with a non-FL DL issued exclusively to unauthorized immigrants or others without proof of lawful presence	322.033(1)	Criminal
Expired DL less than 6 months	322.065	Non-moving
Fail to exhibit/faded/altered/mutilated/defaced	322.15 (1)	Non-moving
DL not carried and exhibited on demand	322.15 (1)	Non-moving
Violation of DL restriction	322.16	Moving
Violation of DL restriction imposed by court, commission, or DOC	322.16	Criminal
Learner permit must be accompanied by a person properly licensed, 21 years old or over, and in front seat at right	322.1615 (2)	Moving
Failure to change name within 30 days	322.19 (1)	Non-moving
Failure to change address within 30 days	322.19 (2)	Non-moving
Knowingly possess or display any blank, forged, stolen, fictitious, counterfeit, or unlawfully issued DL	322.212 (1) (a)	Criminal FELONY

DRIVER LICENSE / ID CARDS

Continued

DL with false age by alteration or application	322.212 (5) (b)	Criminal
Habitual Traffic Offender (HTO) Defined	322.264	Definition only
Use of valid out of state DL to operate vehicle in FL while FL DL is suspended	322.30 (1)	Criminal
Knowingly possessing or displaying canceled, revoked, suspended or disqualified DL	322.32 (1)	Criminal
Display or represent of another's DL as driver's DL	322.32 (3)	Criminal
Failure to forfeit on demand any suspended, revoked, cancelled DL	322.32 (4)	Criminal
Allowing unlawful use of own DL	322.32 (5)	Criminal
Apply for or obtain 2 or more DL under different names	322.32 (6)	Criminal
Driving while license suspended, revoked, or cancelled without knowledge	322.34 (1)	Moving
Driving while license suspended, revoked, or canceled with knowledge	322.34 (2) (a)	Criminal
Driving while license suspended, revoked, or canceled with two prior convictions and current violation or most recent prior violation arises from DUI, refusal to submit to DUI test, a traffic offence causing fatality or serious bodily injury, or fleeing/eluding	322.34 (2) (c)	Criminal POSSIBLE FELONY
Driving while license revoked HTO	322.34 (5)	Criminal FELONY
Driving while license permanently revoked	322.341	Criminal

DRIVER LICENSE / ID CARDS

Classes – Restrictions - Endorsement

Commercial License Class

Class A	Trucks or truck combinations weighing with a Gross Vehicle Weight Rating of 26,001 lbs. or more, provided towed vehicle is more than 10,000 lbs.
Class B	Straight trucks weighing 26,001 lbs. Gross Vehicle Weight Rating or more.
Class C	Vehicles transporting placardable amounts of hazardous materials, or vehicles designed to transport more than 15 persons including the driver with a Gross Vehicle Weight Rating of less than 26,001 lbs.

DRIVER LICENSE / ID CARDS

Classes – Restrictions - Endorsement

Non-Commercial License Class

Class E	<p>Any non-commercial motor vehicles with Gross Vehicle Weight Rating (GVWR) less than 26,001 pounds, including passenger cars, 15 passenger vans including the driver, trucks or recreational vehicles and two or three-wheel motor vehicles 50 cc or less, such as mopeds or small scooters. (See below). Farmers and drivers of authorized emergency vehicles who are exempt from obtaining a commercial driver license must obtain a Class E license.</p> <ul style="list-style-type: none">• A resident who holds a valid Florida operator license may continue to operate vehicles for which a CLASS E driver license is required, until the operator license expires.• A 16-year-old cannot drive from 11 PM to 6 AM unless accompanied by 21 year old licensed driver or driving to and from work.• A 17-year-old cannot drive from 1 AM to 5 AM unless accompanied by 21 year old licensed driver or driving to and from work.
Class E-Learner	<p>Motor vehicles less than 8,000 LBS.</p> <ul style="list-style-type: none">• A resident who holds a valid Florida learner license may continue to operate vehicles for which a CLASS E learner license is required, until the license expires.• Learner license has the following conditions:<ol style="list-style-type: none">1. Always with a licensed driver who is at least 21 years old and occupies the front seat.2. Only drive during daylight hours for the first three months, and until 10 PM thereafter.3. Does not allow for the operation of a motorcycle.
Motorcycle	<p>For those authorized to operate motorcycle, the following abbreviation will appear on the front of the driver license under the expiration date: “A” for MOTORCYCLE ALSO or “O” for MOTORCYCLE ONLY.</p>

DRIVER LICENSE / ID CARDS

Classes – Restrictions - Endorsement

Restrictions (2020 and Before)

- | | |
|------------------------------------|---------------------------------|
| A. Corrective Lenses | P. Probation-Interlock Device |
| B. Outside Rearview Mirror | S. Other Restrictions |
| C. Business Purposes | T. No Passenger on Motorcycle |
| D. Employment Purposes | V. CDL Medical Variance |
| E. Daylight Driving Only | X. Medical Alert Bracelet |
| F. Automatic Transmission | Y. Education Purposes |
| G. Power Steering | 1. Vehicle Without Airbrakes |
| I. Directional Signals | 2. (CDL) Intrastate Only |
| J. Grip on Steering Wheel | 3. (CDL) Bus Only |
| K. Hearing Aid | 4. CMV < 26,001 LBS. GVWR |
| L. Seat Cushion | 5. No Tractor Trailer |
| M. Hand Control or Pedal Extension | 6. No Class A Passenger Vehicle |
| N. Left Foot Accelerator | 7. No Class B Passenger Vehicle |

Restrictions (December 2020 to Present)

- B. Corrective Lenses
- C. Mechanical Aid
- D. Prosthetic Aid
- E. No Manual Transmission Equipped CMV
- F. Outside Mirror
- G. Limited Daylight Driving
- H. Limited to Employment
- I. Limited Other Restriction
- J. Other
- K. CDL Intrastate Only
- L. No Air Brake Equipped CMV
- M. No Class A Passenger Vehicle
- N. No Class A or B Passenger Vehicle
- O. No Tractor Trailer CMV
- P. No Passengers in CMV Bus (CLP Only)
- V. Medical Variance Documentation Required
- W. Farm Waiver
- X. No Cargo in CMV Tank Vehicle (CLP Only)
- Z. No Full Airbrake Equipped CMV
- 1. Business Purposes
- 2. Probation Interlock
- 3. Medical Alert Bracelet
- 4. No Manual Transmission
- 5. Power Steering
- 6. Directional Signals
- 7. Grip on Steering Wheel
- 8. Left Foot Accelerator
- 9. Hearing Aid

Endorsements

- H. Any vehicle used to transport hazardous materials in placardable amounts.
- N. A tank vehicle designed to transport any liquid or gaseous material with designed capacity of 1,000 gallons or more.
- P. Any vehicles, public or private, designed to transport 16 or more passengers, including the driver
- S. A commercial motor vehicle (requires CDL) used to transport pre-primary, primary, or secondary school students from home to school, from school to home, or to and from school-sponsored events. Does not include a bus used as a common carrier.
- T. Combination vehicles with double / triple trailers
- X. Any tank vehicle used to transport placardable amounts of hazardous materials

Acronyms & Abbreviations

CDL = Commercial Driver License
CMV = Commercial Motor Vehicle
GVWR = Gross Vehicle Weight Rating
LBS. = Pounds
MTRCL Also = Motorcycle Also
MTCRL Only = Motorcycle Only
< = Less Than

DRIVER LICENSE / ID CARDS

Military

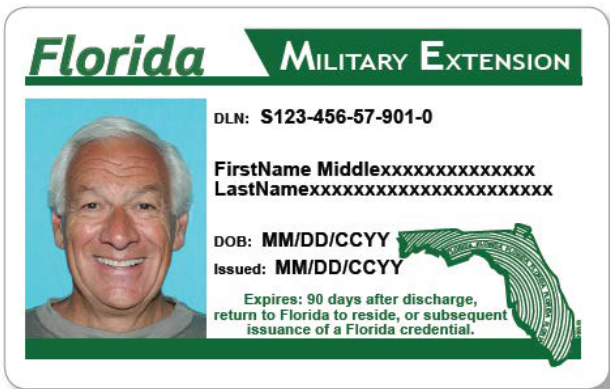

DRIVER LICENSE / ID CARDS

Updates



Issue dates: August 2017 – August 2019

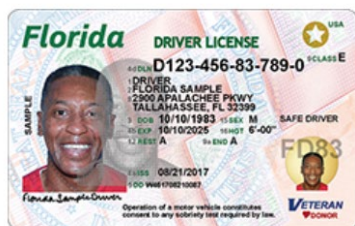

Issue dates: May 2019 – Present

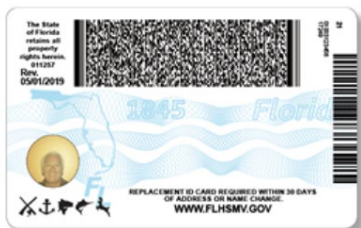
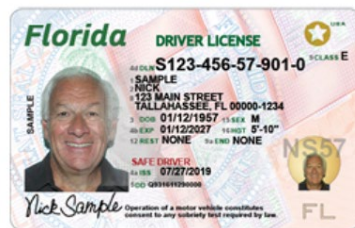

Issue dates: August 2020 – Present

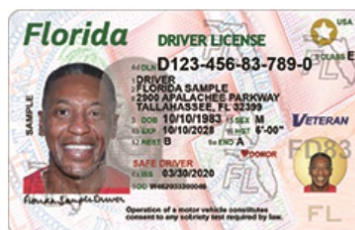

DRIVER LICENSE / ID CARDS

Symbols

QUICK REFERENCE: DESIGNATIONS

Descriptor	Symbol	Location on Card	Explanation
Deaf/Hard of Hearing		Front	Designation showing that the cardholder is Deaf or hard of hearing.
Developmentally Disabled	D	Front	Designation showing that the cardholder is developmentally disabled. Currently only available on ID cards.
Insulin Dependent	INSULIN DEP	Front	Designation showing that the cardholder is insulin dependent.
Organ Donor	 DONOR	Front	Designation showing that the cardholder wishes to be an organ donor.
Sexual Offender	943.0435, F.S.	Front	Identifier showing that the cardholder is a sexual offender.
Sexual Predator	SEXUAL PREDATOR	Front	Identifier showing that the cardholder is a sexual predator.
Veteran	VETERAN	Front	Designation showing that the cardholder is a veteran of the United States Armed Forces.
FWC Lifetime Boating Safety		Back	Designation showing that the cardholder has been issued a lifetime boating safety education identification card from the Florida Fish and Wildlife Conservation Commission (FWC).
FWC Lifetime Freshwater		Back	Designation showing that the cardholder has been issued a lifetime FWC freshwater fishing license.
FWC Lifetime Hunting		Back	Designation showing that the cardholder has been issued a lifetime FWC hunting license (includes hunting license; and deer, wildlife management area, archery, muzzle-loading gun, crossbow, turkey and Florida waterfowl permits).
FWC Lifetime Saltwater		Back	Designation showing that the cardholder has been issued a lifetime FWC saltwater fishing license (includes snook and lobster permits).
FWC Lifetime Sportsman's		Back	Designation showing that the cardholder has been issued a lifetime FWC sportsman's license (includes hunting, freshwater and saltwater fishing licenses; and deer, wildlife management area, archery, muzzle-loading gun, crossbow, turkey, Florida waterfowl, snook and lobster permits).

IDENTIFICATION CARDS

Unlawful to display or possess altered or fraudulently obtained card	322.051 (6) (a)	Criminal
Lend out to another or allow use of their ID card by another	322.051 (6) (b)	Criminal
Represent ID card not issued to them as theirs	322.051 (6) (c)	Criminal
Permit any unlawful use of ID card by the subject	322.051 (6) (d)	Criminal
Duplicate / Possess fake ID card	322.051 (6) (f)	Criminal

DRIVER LICENSE / ID CARDS

Graduated Driver License (GDL) Restrictions

LICENSE TYPE	HOURS	NOTES
Learner License	Daylight hours for first three months after license issued - until 10 p.m. after three months	ALWAYS accompanied by a licensed driver 21+ Must hold for a minimum of 12 months or until 18th birthday, whichever comes first. Required 50 hours of supervised driving, 10 of which must be at night.
Driver License - 16 years old	NOT between 11 p.m. to 6 a.m.	Unless driving to or from work OR accompanied by a licensed driver 21+
Driver License - 17 years old	NOT between 1 a.m. to 5 a.m.	Unless driving to or from work OR accompanied by a licensed driver 21+

DRIVER LICENSE / ID CARDS

Graduated Driver License (GDL)

Minimum age of 16 for Class E License	322.05 (1)	Moving
Learner License required for 12 months	322.05 (2) (a)	Moving
Required supervised driving for 50 hours, with no less than 10 of those hours being at night	322.05 (3)	Moving
Nighttime driving restrictions for 16 years old	322.16 (2)	Moving
Nighttime driving restrictions for 17 years old	322.16 (3)	Moving
Minimum age of 15 required for Learner License	322.1615 (1)	Moving

DUI / ALCOHOL

Driving while under influence (DUI) of alcohol or chemical controlled substance with BAC .08 or higher	316.193 (1)	Criminal
DUI - Bicycle	316.193 (1)	Criminal
DUI - 3rd conviction within 10 years	316.193 (2) (b) 1	Criminal FELONY
DUI - 4th conviction in a lifetime	316.193 (2) (b) 3	Criminal FELONY
DUI Crash - Property Damage	316.193 (3) (a) (b) (c) 1	Criminal
DUI Crash - Serious Injury	316.193 (3) (a) (b) (c) 2	Criminal
DUI Manslaughter	316.193 (3) (a) (b) (c) 3	Criminal FELONY
Possession of open container (Driver) when operating a Vehicle or bicycle	316.1936 (2) (a)	Moving
Possession of open container (Passenger) when vehicle or bicycle is being operated	316.1936 (2) (a)	Non-moving
Possession of open container (Driver) when vehicle is parked on a road	316.1936 (2) (b)	Moving
Possession of open container (Passenger) when vehicle is parked on a road	316.1936 (2) (b)	Non-moving
Tampering with ignition interlock device	316.1937 (6) (a)	Non-moving
Interlock Devices - Blowing into interlock of another	316.1937 (6) (c)	Non-moving
Knowingly lending non-interlock vehicle to persons with interlock driving restrictions	316.1937 (6) (d)	Non-moving
DUI - Refusal to submit breath, blood, or urine *Prior refusal required	316.1939 (1)	Criminal
DUI - Driving CMV with BAC .04 or higher * Disqualifies Operating CMV	322.62 (2) (b)	Moving

EQUIPMENT

Defective / Faulty / Unsafe Equipment (Lights, brakes, tires, etc...) * notation of defect on UTC for full violation *option to have equipment fixed within 30 days for a reduced fine	316.215 (1) 316.610	Non-moving
Owner of vehicle allowing use of vehicle that has unsafe or defective equipment	316.215 (1)	Non-moving
Must have white tag light making plate visible from 50 feet	316.221 (2)	Non-moving
Stop lamps required	316.222 (1)	Non-moving
Turn signals required	316.222 (2)	Non-moving
License plate – white light	316.224 (3)	Non-moving
Red or blue lights on vehicle visible from directly in front	316.2397 (1)	Non-moving
No or improper brakes	316.261	Non-moving
Horn required	316.271 (1)	Non-moving
Exhaust system (noise)	316.272	Non-moving
Modify exhaust system in vehicle to be louder than the motor vehicle originally was (No / Improper muffler)	316.293 (5) (a)	Non-moving
Mirror required	316.294	Non-moving
Gasoline vehicle having visible exhaust smoke over 5 seconds	316.2935 (2)	Non-moving
Diesel engines having visible exhaust smoke over 5 seconds	316.2935 (3)	Non-moving
Windshield must be fixed in an upright position	316.2952 (1)	Non-moving
No windshield wipers	316.2952 (3)	Non-moving
Faulty windshield wipers	316.2952 (4)	Non-moving

HEADLIGHTS

Head lights required from sunset to sunrise	316.217 (1) (a)	Moving
Head lights required during any rain, fog, smoke	316.217 (1) (b)	Moving
Vehicles will be equipped with at least 2 headlights, and can't have tinted coverings	316.220 (1)	Non-moving
Headlights must be between 24" to 54" above the ground	316.220 (2)	Non-moving
Must dim high beam lights within 500 feet of oncoming vehicle	316.238 (1) (a)	Moving
Must dim high beam lights within 300 feet from the rear	316.238 (1) (b)	Moving
Can't have more than 4 forward facing lights (including headlights)	316.2396 (2)	Non-moving

INSURANCE

Proof of insurance (required by owner or lessee of vehicle) * If insurance was valid at time of stop a dismissal fee of \$10 will be paid to Clerk of court with proof of insurance. If driver is convicted of this an immediate suspension will occur (non-resident exemption 627.733)	316.646 (1)	Non-moving
Misrepresentation of insurance: when subject knowingly provides insurance that is not currently in force	316.646 (4)	Criminal

LANE

Failure to remove disabled vehicle obstructing traffic	316.071	Non-moving
Violation of lane direction control signals	316.0765	Moving
Driving around a barricade	316.078 (1)	Moving

LANE

Continued

Slow vehicles proceeding less than the flow of traffic shall be in the right-hand lane	316.081 (2)	Moving
Left lane impeding traffic	316.081 (3)	Moving
Vehicles traveling in opposite directions will pass each other to the right	316.082 (1)	Moving
No vehicle may pass on the right by driving off the pavement	316.084 (2)	Moving
Improper change of lane – oncoming traffic	316.085 (1)	Moving
Improper change of lane – same direction	316.085 (2)	Moving
Driving wrong way on a one-way street	316.088 (2)	Moving
Vehicles will travel right around rotary traffic islands	316.088 (3)	Moving
Vehicle shall be driven entirely in a single lane	316.089 (1)	Moving
Center lane: passing, turning left, or as directed by a TCD	316.089 (2)	Moving
Failure to obey TCD prohibiting lane change	316.089 (4)	Moving
Driving on wrong side of divided highway	316.090 (1)	Moving
Crossing or driving on median strip or marked divider of divided highway	316.090 (2)	Moving
Driving or crossing a median strip when no TCD or opening allows it	316.090 (2)	Moving
Failure to move over for disabled, emergency, or sanitation vehicle	316.126 (1) (b) 1	Moving
Failure to slow down (slow to 20 MPH less than the posted speed limit when speed limit is greater than 25 MPH, or slow to 5 MPH when the speed limit is 20 MPH or less)	316.126 (1) (b) 2	Moving

LANE Continued

Failure to use signal to change lane or turn a vehicle from a direct course	316.155 (1)	Moving
Vehicle impeding the flow of traffic	316.183 (5)	Moving
Blocking intersection or cross walk	316.2061	Moving
No vehicle shall deprive a motorcycle full use of its lane	316.209 (1)	Moving
Motorcycles may not pass in between lanes	316.209 (3)	Moving

LIGHTS (VEHICLE)

Head lights required from sunset to sunrise	316.217 (1) (a)	Moving
Head lights required during any rain, fog, smoke	316.217 (1) (b)	Moving
Vehicles will be equipped with at least 2 headlights, and can't have tinted coverings that alter the color of the white	316.220 (1)	Non-moving
Headlights must be between 24" to 54" above the ground	316.220 (2)	Non-moving
Vehicles must have 2 red taillights when applied must be visible for 1,000 feet, shall be level, and can't have coverings which alters the color	316.221 (1)	Non-moving
Must have white tag light making plate visible from 50 feet	316.221 (2)	Non-moving
Every vehicle / trailer shall be equipped with 2 brake lights	316.222 (1)	Non-moving
Turn signals are required on all vehicles / trailers	316.222 (2)	Non-moving
Defective or improper clearance lamps – must be visible up to 550 feet	316.226 (2)	Non-moving
No more than 2 fog lamps mounted to front between 12" to 30" off ground	316.233 (2)	Non-moving

LIGHTS (VEHICLE)

Continued

Auxiliary passing lamps – no more than 2 mounted on front between 24" to 42" off ground	316.233 (3)	Non-moving
Brake light covering prohibited if it alters visibility at 300 feet	316.234 (1)	Non-moving
Front turn signals shall be white or amber in color and rear turn signals shall be red or amber in color	316.234 (2)	Non-moving
Back up lights shall not be on when vehicle is going forward	316.235 (4)	Non-moving
Must dim high beam lights within 500 feet of oncoming vehicle	316.238 (1) (a)	Moving
Must dim high beam lights within 300 feet from the rear	316.238 (1) (b)	Moving
Can't have more than 4 forward facing lights (including headlights)	316.2396 (2)	Non-moving
No red or blue lights that can be directly seen from the front of vehicle	316.2397 (1)	Non-moving
No vehicle may show or display blue lights	316.2397 (2)	Non-moving
No person shall use on a vehicle an unapproved lighting device (Has to be a D.O.T. approved device)	316.241 (3)	Non-moving

MISCELLANEOUS

Improper start of vehicle when parked / stopped / standing until it can be done safely	316.154	Moving
Reckless driving (willful or wanton disregard for safety of persons or property)	316.192 (1) (a)	Criminal
Toll violations	316.1001 (1)	Moving
Driving through safety zone	316.1355	Moving
Careless driving	316.1925 (1)	Moving

MISCELLANEOUS

Continued

Flee / Elude from a marked vehicle with lights and siren	316.1935 (2)	Criminal FELONY
Flee / Elude from marked vehicle with lights and siren; drives at high speed or with wanton disregard for safety	316.1935 (3) (a)	Criminal FELONY
Flee / Elude from marked vehicle with lights and siren causes serious bodily injury or death to person or LEO involved in pursuit	316.1935 (3) (b)	Criminal FELONY
Stopping to load or unload passenger(s)	316.1945 (1) (a) 12	Non-moving
Driving a vehicle on a sidewalk or bicycle path	316.1995 (1)	Moving
Opening door into moving traffic	316.2005	Non-moving
Driver allows passenger to ride on exterior of vehicle	316.2015 (1)	Moving
Passenger riding on exterior of vehicle	316.2015 (2) (a)	Non-moving
Following a fire truck within 500 feet while traveling to fire alarm	316.2025	Moving
Parking within the block where fire truck has stopped in answer to a fire alarm	316.2025	Non-moving
Driving over an unprotected fire hose without consent	316.2034	Moving
Obstruction of public streets	316.2045 (1)	Pedestrian
Golf cart operating on a public road by any person 18 years or younger without learners license	316.212	Moving
Improper use of horn	316.271 (3)	Non-moving
Television in view of driver	316.303 (1)	Non-moving
Wearing headset, headphone, or another listening device while driving (exemptions, see FSS)	316.304 (1)	Non-moving

MISCELLANEOUS

Continued

Littering from vehicle over 15 lbs. less than 500 lbs.	403.413 (6) (b)	Criminal
Littering more than 500 lbs. or hazardous waste	403.413 (6) (c)	Criminal FELONY

MOTORCYCLE

Racing on highways, street takeovers, and stunt driving	316.191 (2) (a)	Criminal
Driving moped upon a sidewalk with motor operating	316.208 (4)	Moving
Carrying more persons than designed for; passenger not seated in proper position (passenger riding in front of operator)	316.2085 (1)	Moving
Improper riding (facing forward, one leg on each side of motorcycle, both wheels on ground)	316.2085 (2)	Moving
Tag improperly affixed to vehicle, must remain clearly visible from rear at all times	316.2085 (3)	Moving
Carrying items preventing both hands from being on handlebars	316.2085 (4)	Moving
Riding in a position that interferes with the operation or control of the motorcycle	316.2085 (5)	Moving
Motorcycle passing within occupied lane	316.209 (2)	Moving
Motorcycle operating between lanes or vehicles	316.209 (3)	Moving
Having more than 2 motorcycles abreast in a single lane	316.209 (4)	Moving
Motorcycle must have footrest for passenger	316.2095 (1)	Non-moving

MOTORCYCLE

Continued

Motorcycles with handle bars higher than operator's shoulders	316.2095 (2)	Non-moving
No eye protection	316.211 (2)	Non-moving
No helmet: does not have \$10,000 in medical coverage rider / operator, over 21	316.211 (3) (b)	Non-moving
Moped no helmet under 16 years old (rider or operator)	316.211 (4)	Non-moving
Person under 21 must have the unique tag	316.211 (6)	Non-moving
Motorcycle must have at least 1 headlight / no more than 2	316.400 (1)	Non-moving
Motorcycle head light shall be between 24" and 54" off the ground	316.400 (2)	Non-moving
Motorcycle headlight(s) will be on while on public roads	316.405 (1)	Moving
Motorcycle will have at least one tail lamp between 20" and 72" off the ground	316.410 (1)	Non-moving
Motorcycle tag light (white) and visible from 50'	316.410 (2)	Non-moving
Motorcycle or motor - driven cycle shall have a red reflector on the rear	316.415	Non-moving
No stop lamp	316.420	Non-moving
No lights on parked cycle	316.425 (1)	Non-moving
No or improper brakes	316.440	Non-moving
No / Improper horn	316.455 (1)	Non-moving
Unlawful siren / bell / or whistle	316.455 (3)	Non-moving
No / Improper muffler	316.455 (6)	Non-moving
No / Improper mirror	316.455 (7)	Non-moving
No motorcycle endorsement	322.03 (4)	Criminal

MOVE OVER

Failure to move over	316.126 (1) (b) 1	Moving
Failure to slow down (slow to 20 MPH less than the posted speed limit when speed limit is greater than 25 MPH, or slow to 5 MPH when the speed limit is 20 MPH or less)	316.126 (1) (b) 2	Moving

PARKING

Stopping / standing / parking (double parked) on the roadway side of any vehicle stopped or parked at the edge or curb of a street	316.1945 (1) (a) 1	Non-moving
Stopping / standing / parking on a sidewalk	316.1945 (1) (a) 2	Non-moving
Stopping / standing / parking within an intersection	316.1945 (1) (a) 3	Non-moving
Stopping / standing / parking on a crosswalk	316.1945 (1) (a) 4	Non-moving
Stopping / standing / parking on a bridge or elevated area on a highway or tunnel	316.1945 (1) (a) 7	Non-moving
Stopping / standing/ parking on railroad tracks	316.1945 (1) (a) 8	Non-moving
Stopping / standing/ parking on bicycle path	316.1945 (1) (a) 9	Non-moving
Stopping / standing/ parking where an official TCD prohibits stopping	316.1945 (1) (a) 10	Non-moving
Standing or parking vehicle in front of a public or private driveway	316.1945 (1) (b) 1	Non-moving
Standing or parking within 15 feet of a fire hydrant	316.1945 (1) (b) 2	Non-moving
Standing or parking within 20 feet of a crosswalk at intersection	316.1945 (1) (b) 3	Non-moving
Standing or parking a vehicle within 30 feet to any flashing signal, stop sign, or traffic control signal located at the side of a roadway	316.1945 (1) (b) 4	Non-moving

PARKING

Continued

Standing or parking on an exclusive bicycle lane	316.1945 (1) (b) 6	Non-moving
Improper parking two-way road	316.195 (1)	Non-moving
Illegally parked in a handicap parking space	316.1955 (1)	Non-moving
Unattended vehicle left running	316.1975 (1)	Non-moving
Fraudulently obtained / unlawful display a disabled parking permit belonging to another person who is not being transported	320.0848 (7)	Criminal
Stopping / standing/ parking at a recharging station in a non-electric vehicle	366.94 (3) (a)	Non-moving

PASSING

Passing on the left of an approaching vehicle	316.082 (1)	Moving
Give half of the road when passing opposite direction	316.082 (2)	Moving
Cutting-In	316.083 (1)	Moving
Passing a bicycle with improper distance between – minimum 3 feet required	316.083 (2)	Moving
Must use signal device when passing vehicle	316.083 (1)	Moving
Failure to give right of way to overtaking vehicle	316.083 (5)	Moving
Passing on right ONLY under safe conditions, though NEVER off of pavement or main-traveled portion of roadway	316.084 (2)	Moving
Improper change of lane by pulling out in front of a vehicle going same direction	316.085 (2)	Moving
Passing within 200 feet of oncoming traffic	316.085 (1)	Moving

PASSING

Continued

No passing on the crest of a hill when view is obstructed	316.087 (1) (a)	Moving
No passing on a curve when view is obstructed	316.087 (1) (b)	Moving
No passing within 100 feet of an intersection	316.087 (1) (c)	Moving
No passing within 100 feet of R/R crossing	316.087 (1) (d)	Moving
A vehicle may not overtake a stopped vehicle that is allowing pedestrian in crosswalk to cross	316.130 (9)	Moving
Failure to stop (passing) for a school bus displaying a stop signal	316.172 (1) (a)	Moving
Passing a school bus on the enter / exit side while bus is stopped and displaying a stop signal	316.172 (1) (b)	Moving Mandatory Court

PEDESTRIAN

Pedestrian not to enter roadway to cross signalized crosswalk on yellow light	316.075 (1) (b) 2	Pedestrian
Pedestrian must not enter roadway on RED light	316.075 (1) (c) 2 b	Pedestrian
Pedestrian failure to yield to emergency vehicle	316.126 (2)	Pedestrian
Pedestrian failure to obey pedestrian control signal	316.130 (1)	Pedestrian
Pedestrian must use sidewalk when practicable	316.130 (3)	Pedestrian
Pedestrian shall walk only on left shoulder facing traffic (as practicable)	316.130 (4)	Pedestrian

PEDESTRIAN

Continued

No person shall stand in the portion of a roadway paved for vehicular traffic for the purpose of soliciting a ride, employment, or business from the occupant of any vehicle	316.130 (5)	Pedestrian
No person shall stand on or in proximity of a street for the purpose of guarding of a vehicle while parked or about to park (holding a parking space)	316.130 (6)	Pedestrian
Pedestrian to yield to vehicles upon roadway when crossing in area where tunnel or crossing has been provided	316.130 (7) (c)	Pedestrian
Pedestrian shall not leave curb/place of safety into path of vehicle so close that it is impossible for driver to yield	316.130 (8)	Pedestrian
Pedestrian crossing anywhere other than marked/unmarked crosswalk at an intersection shall yield to vehicles on roadway	316.130 (10)	Pedestrian
Pedestrian not to cross unless in marked crosswalk when between adjacent intersections with operational TCD	316.130 (11)	Pedestrian
Pedestrian must cross roadway at right angles to curb unless in marked crosswalk	316.130 (12)	Pedestrian
Pedestrian to move upon right half of crosswalk	316.130 (13)	Pedestrian
Pedestrian must not cross roadway at an intersection diagonally unless authorized by TCD	316.130 (14)	Pedestrian

PEDESTRIAN

Continued

Pedestrian not to remain on bridge, or between crossing gate at railroad crossing if closed or opening	316.130 (16)	Pedestrian
Pedestrians jumping or diving from a public owned bridge	316.130 (17)	Pedestrian
No pedestrians on limited access facility or ramps	316.130 (18)	Pedestrian
Pedestrian illegally carrying in a raised or extended position a white cane or white cane tipped red unless blind	316.1301 (1)	Criminal
Pedestrian obstructing or hindering traffic	316.2045 (1) (a)	Pedestrian





RACING

Driving any vehicle in a race on the highway, road, or parking lot	316.191 (2) (a)	Criminal
Participating or coordinating a race	316.191 (2) (b)	Criminal
Knowingly riding as a passenger in a race	316.191 (2) (c)	Criminal
Slowing or stopping traffic for a race	316.191 (2) (d)	Criminal
Driving any vehicle to film a race (Does not apply to news media)	316.191 (2) (e)	Criminal
Operate a fueling vehicle for a vehicle involved in a race	316.191 (2) (f)	Criminal
Spectator at a race	316.191 (4) (a)	Moving

SAFETY BELTS & CHILD RESTRAINTS

Passengers under 18 must be restrained if riding in the bed of a pickup truck while operated on a limited access facility	316.2015 (2) (b)	Non-moving
Infant through 3 years old must be in a separate, federally approved child restraint device or integrated child seat.	316.613 (1) (a) 1	Moving
Child 4 to 5 years may be in a separate carrier, integrated child seat or child booster seat	316.613 (1) (a) 2	Moving
Anyone under 18 years old not belted (driver is cited)	316.614 (4) (a)	Non-moving
Driver not belted	316.614 (4) (b)	Non-moving
Front passenger not belted (if over 18)	316.614 (5)	Non-moving
Child 6 or younger left unattended in vehicle for more than 15 minutes	316.6135 (1) (a)	Criminal
Child 6 or younger left in vehicle with engine running	316.6135 (1) (b)	Non-moving

FLORIDA USE GUIDENCE

Birth to 3		4 to 5		6 to 18
Approved Carrier Only		Approved Carrier or Booster		Safety Belt
				
Rear-Facing Carrier	Forward-Facing Carrier	Forward-Facing Carrier	Booster Seat	Vehicle Safety Belt

SPEEDING

Unlawful speed	316.183 (2)	Moving
Failure to use due care - Too fast for conditions (i.e. special hazard, smoke, fog)	316.183 (4) (e)	Moving
Driving too slow impeding traffic	316.183 (5)	Moving
Exceeding posted speed in Work Zone (fines doubled)	316.183 (6)	Moving
Unlawful speed State Road	316.187 (1)	Moving
Unlawful speed Limited Access Highway	316.187 (2) (a)	Moving
Unlawful Speed City / Municipality Road	316.189 (1)	Moving
Unlawful speed County Road	316.189 (2)	Moving
Unlawful speed in a School Zone (fines doubled)	316.1895 (10)	Moving
Jurisdiction may enforce speed limits in school zone by means of a speed detection system	316.008 (9) (b)	Moving
Reckless driving	316.192 (1) (a)	Criminal
Reckless driving with property damage or personal injury	316.192 (3) (c) (1)	Criminal
Reckless driving serious bodily injury	316.192 (3) (c) (2)	Criminal FELONY
Unlawful speed 50 MPH Over Speed Limit	316.1926 (2)	Moving
Unlawful speed 50 MPH Over Speed Limit 3rd conviction	318.14 (13) (c)	Criminal FELONY

30 MPH Over Posted Speed Limit = Mandatory Court Appearance
Speeding Fines Doubled in Active School Speed Zones
Speeding Fines Doubled in Work Zones Where Workers are Present

TAG / REGISTRATION

Failure to register a vehicle	320.02 (1)	Criminal
Change of address required within 30 days	320.02 (4)	Criminal
Altering a registration, tag, or sticker by any means	320.061	Moving
Expired tag 6 months or less	320.07 (3) (a)	Non-moving
Expired tag more than 6 months (first offense)	320.07 (3) (b)	Non-moving
Expired tag more than 6 months (Second or subsequent offense)	320.07 (3) (c)	Criminal
Temporary tag expired 7 days or less	320.131 (3)	Non-moving
Temporary tag must be displayed in the license plate bracket on the exterior of the vehicle	320.131 (4) (a)	Moving
Knowingly and willfully abuses or misuses a temporary tag to avoid reregistering a vehicle	320.131 (5)	Criminal
Manufacture, possess, sale or dispose of counterfeit tags, stickers, or registration	320.26 (1) (a)	Criminal FELONY
Attached tag or sticker not assigned or legally transferred	320.261	Criminal
Nonresident must register vehicle within 10 days of gaining employment or putting child in school	320.38	Criminal
Refusal to surrender license plate / DL / registration	320.58 (2)	Criminal
Tag inside vehicle, obscured defaced, or not securely fastened; must be visible and legible at all times from 100 feet	316.605 (1)	Non-moving
Failure to carry and exhibit registration	320.0605 (1) (a)	Non-moving

TRAFFIC CONTROL DEVICES

Refuse to obey Police or Firefighters	316.072 (3)	Criminal
Failure to obey traffic control device	316.074 (1)	Moving
Avoid traffic control device (cutting through a business / cutting across to avoid)	316.074 (2)	Moving
Steady red light	316.075 (1) (c) 1	Moving
Right turn on red - failure to stop / yield to pedestrians and other traffic	316.075 (1) (c) 1 a	Moving
Left turn on red - One-way street / yield to pedestrians and other traffic	316.075 (1) (c) 1 b	Moving
Failure to stop at a flashing red light	316.076 (1) (a)	Moving
Driving around a detour sign or barricade	316.078 (1)	Moving
Failure to stop at stop sign	316.123 (2) (a)	Moving
Failure to yield at a four way stop	316.123 (2) (b)	Moving
Failure to stop or yield at a yield sign	316.123 (3)	Moving
Failure to stop for an inoperative traffic light	316.1235	Moving
Driving through or around a closed railroad bar (applies if it is opening or closing)	316.1575 (2)	Moving

TURNING

Failure to yield to oncoming traffic when making left turn	316.122	Moving
Improper right turn (turned too wide)	316.151 (1) (a) (1)	Moving
Improper left turn (turning left from other than left lane)	316.151 (1) (b)	Moving
Failure to turn as directed by TCD	316.151 (2)	Moving
U Turn - Improper, unsafe or prohibited	316.1515	Moving
Improper turn on hill or curve	316.152	Moving
Turn signal required when changing lanes / passing a vehicle	316.155 (1)	Moving
Must use turn signal continuously within 100 feet of turn	316.155 (2)	Moving
Failure to signal for stopping or slowing speed	316.155 (3)	Moving
Improper hand signals	316.157	Moving

YIELD RIGHT OF WAY

Green arrow - failure to yield while turning	316.075 (1) (a) 2	Moving
Failure to yield to pedestrian when turning right on red	316.075 (1) (c) 1 a	Moving
Failure to yield to a flag person	316.079 (1)	Moving
Failure to yield for flag person or escort vehicle with oversized load	316.079 (2)	Moving
Failure to yield to public transit vehicle	316.0815 (1)	Moving
Failure to give right of way to overtaking vehicle	316.083 (5)	Moving

YIELD RIGHT OF WAY

Continued

Failure to yield to a vehicle already in intersection	316.121 (1)	Moving
Failure to yield at State Road Intersection from road not subject to control	316.121 (3)	Moving
Failure to yield at sidewalk from alley, driveway, building to vehicles approaching	316.125 (1)	Moving
Failure to yield at sidewalk from alley, driveway, building to pedestrian	316.125 (2)	Moving
Failure to yield to emergency vehicle	316.126 (1) (a)	Moving
Failure to yield right of way to pedestrian at crosswalk with signage	316.130 (7) (b)	Moving
Failure to yield right of way to pedestrian in crosswalk when lights aren't working, no signal or sign	316.130 (7) (c)	Moving
Failure to yield to a blind pedestrian	316.1301 (2)	Moving
Failure to stop for mobility impaired pedestrian crossing an intersection	316.1303 (1)	Moving
Failure to yield to the right of way to a funeral procession	316.1974 (3) (a)	Moving

WINDOW TINT

Tint covering windshield below AS/1 line	316.2952 (2) (b)	Non-moving
Window tint - Front driver and passenger side below 25% (reflective tint or tint changing color of window)	316.2953	Non-moving
Window - Rear driver and passenger side non-transparent or obscured or altering the windows color	316.2954 (1)	Non-moving
Window - Rear driver and passenger side below 15%	316.2954 (1) (a)	Non-moving

ABBREVIATIONS STATE / TERRITORY

ALABAMA	AL	NEBRASKA	NE
ALASKA	AK	NEVADA	NV
ARIZONA	AZ	NEW HAMPSHIRE	NH
ARKANSAS	AR	NEW JERSEY	NJ
CALIFORNIA	CA	NEW MEXICO	NM
COLORADO	CO	NEW YORK	NY
CONNECTICUT	CT	NORTH CAROLINA	NC
DELAWARE	DE	NORTH DAKOTA	ND
DIST. OF COLUMBIA	DC	OHIO	OH
FLORIDA	FL	OKLAHOMA	OK
GEORGIA	GA	OREGON	OR
HAWAII	HI	PENNSYLVANIA	PA
IDAHO	ID	PUERTO RICO	PR
ILLINOIS	IL	RHODE ISLAND	RI
INDIANA	IN	SOUTH CAROLINA	SC
IOWA	IA	SOUTH DAKOTA	SD
KANSAS	KS	TENNESSEE	TN
KENTUCKY	KY	TEXAS	TX
LOUISIANA	LA	UTAH	UT
MAINE	ME	VERMONT	VT
MARYLAND	MD	VIRGIN ISLANDS	VI
MASSACHUSETTS	MA	VIRGINIA	VA
MICHIGAN	MI	WASHINGTON	WA
MINNESOTA	MN	WEST VIRGINIA	WV
MISSISSIPPI	MS	WISCONSIN	WI
MISSOURI	MO	WYOMING	WY
MONTANA	MT		

Commercial motor vehicle” means any vehicle which is not owned or operated by a governmental entity, which uses special fuel or motor fuel on the public highways, and which has a gross vehicle weight of 10,001 pounds or more, or has three or more axles regardless of weight, or is used in combination when the weight of such combination exceeds 26,001 pounds gross vehicle weight. (CMV is defined in F.S.S 316, 320, 322, 207; definition may / will vary depending on Chapter)

CDL LICENSE REQUIREMENTS

Class A: Any combination of vehicles with a Gross Combination Weight Rating (GCWR) of 26,001 lbs. or more, provided the Gross Vehicle Weight Rating (GVWR) of the vehicle(s) being towed is in excess of 10,000 lbs.

Class B: A Single Vehicle with a GVWR of 26,001 lbs, or more, or any such vehicle towing a vehicle not in excess of 10,000 lbs. GVWR.

Class C: Any vehicle, with a GVWR of less than 26,001 lbs, which is designed to transport 16 or more passengers, including the driver, or is used in the transportation of Haz-Mat, which would require the motor vehicle to be placarded.

Gross Vehicle Weight Rating is found on the VIN Plate of each vehicle.

- 1) **SUSPENDED DL CMV (Driver does not need knowledge of suspension HTO / CMV) F.S.S. 322.34(7) Criminal (1st conviction misdemeanor, 2nd conviction felony, differs from non-cmv as 3rd conviction would be felony; HTO use 322.34 (5))**
- 2) **No / Improper Driver License (Driving outside license classification) Driver needs a CDL Class A F.S.S. 322.54 (2) (a) Criminal**
- 3) **No / Improper Driver License (Driving outside license classification) Driver needs a CDL Class B F.S.S. 322.54 (2) (b) Criminal**
- 4) **Expired CDL (More Than 30 Days) F.S.S. 322.54 (4) (a) Criminal**
- 5) **Expired CDL (30 Days or Less) F.S.S. 322.54 (4) (b) Non-Moving**
- 6) **Violation of DL Restriction F.S.S. 322.16 (1) (c) Criminal; 322.16 (1) (a), (1) (b), (2) (3)**
- 7) **No Endorsement on CDL F.S.S. 322.57 (2) Criminal**
- 8) **Operating CMV under 18 YOA F.S.S. 316.302 (4) Non-moving (AG exemption, 26,001 lbs.)**

CMV INSURANCE

- 1) **Commercial Motor Vehicles 26001 lbs. or more; additional liability insurance coverage F.S.S. 627.7415 Non-Moving (Definition F.S.S. Ch. 207, Ch. 320)**

MEDICAL CARD

- 1) Required for Commercial Vehicle Driver's 26,001 lbs. or More (Exemptions, INTERstate commerce required CMV > 10,000 lbs.)

NON-MOVING VIOLATIONS

- 1) Mandatory Lights: front amber / rear red / side amber (visible from 550') F.S.S. 316.302 (1) (a) Non-moving \$178.50 or F.S.S. 316.215 Non-moving
- 2) Each truck, truck tractor and bus, is required to carry (3) triangle reflectors or (6) flares (3) liquid burning flares (49 CFR 393.95 (f) (1-3). 80" wide or 30' or more overall length. Non-moving F.S.S. 316.300 (1)
- 3) Fire extinguisher must be carried and charged F.S.S. 316.215 or 316.302(1)(a) Non-moving (minimum ratings 49 CFR 393.95)
- 4) Load: dropping, shifting, blowing, escaping, not covered F.S.S. 316.520 Non-moving (AG Exemption for covering in certain scenarios)
- 5) Load not secured by chains or stays F.S.S. 316.525 Non-moving
- 6) Flags Required (not less than 12" square) – Load extends beyond 4' from rear of vehicle. 316.228 (1) Non-moving (also applies to non CMV)
- 7) Mud Flaps Required on Rearmost Wheels of Trucks 26,000 lbs. or more, or trailer, semi-trailer net weight 2000 lbs., unless equipped fenders. 316.252 (1) Non-moving (AG Exemption)
- 8) License Plates REQUIRED Front and Rear 26,001lbs. or more, dump trucks may place the rear license plate no higher than 60". (Truck tractors are only required to display one license plate on the front) F.S.S. 320.0706 Moving (Straight trucks issued 2 plates, decal to be placed on front)
- 9) Window Tint on CMV – not less than 70% - F.S.S. 316.302(1)(a) Non-moving (49 CFR 393.60 (d))
- 10) Improper or Unsafe Equipment – F.S.S. 316.215 Non-moving

316.215 - It is a violation of this chapter for any person to drive or move, or for the owner to cause or knowingly permit to be driven or moved, on any highway any vehicle, or combination of vehicles, which is in such unsafe condition as to endanger any person, which does not contain those parts or is not at all times equipped with such lamps and other equipment in proper condition and adjustment as required in this chapter, or which is equipped in any manner in violation of this chapter or for any person to do any act forbidden, or fail to perform any act required, under this chapter.

Vehicle Configuration

Bus (9-15 Seats, Including Driver)



Bus (16 or More Seats, Including Driver)



Single-Unit (2 Axles, 6 Tires)



Single-Unit (3 or More Axles)

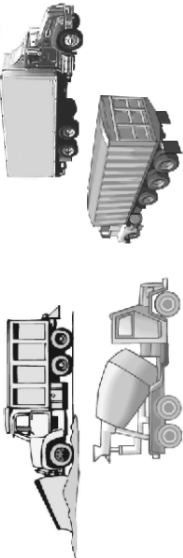

Truck/Trailer (Single-Unit Truck Pulling a Trailer)



Truck Tractor (Bobtail)



Tractor/Semi Trailer (One Trailer)



Truck Tractor/Double (Two Trailers)



Truck Tractor/Triple (Three Trailers)



Revised 06/05



Cargo Body Type

Bus (9-15 Seats, Including Driver)



Bus (16 or More Seats, Including Driver)



Van/Enclosed Box



Cargo Tank



Flat Bed



Dump



Concrete Mixer



Auto Transporter



Garbage/Refus

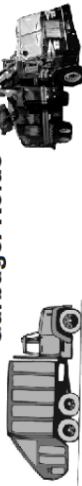

Grain, Chips, Gravel



Pole



Log



Intermodal Chassis



Vehicle Towing Motor Vehicle



No Cargo Body



Federal Motor Carrier
Safety Administration



U.S. Department of Transportation
www.fmcsa.dot.gov

Commercial Driver's License (CDL) Endorsements

CDL ENDORSEMENTS

Double/Triple Trailers (T)

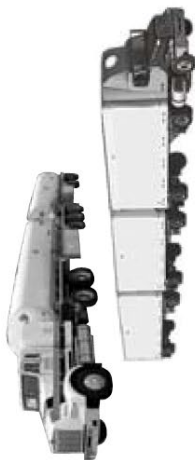

Passenger Vehicles (P)



Tank Vehicles (N)



**Hazardous Materials (H)
(any size vehicle)**



School Buses (S)

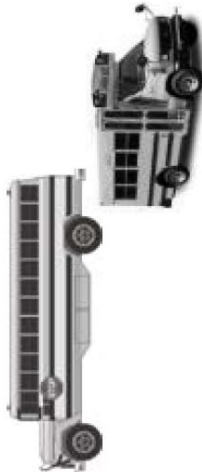

Tank & Hazardous Materials (X)

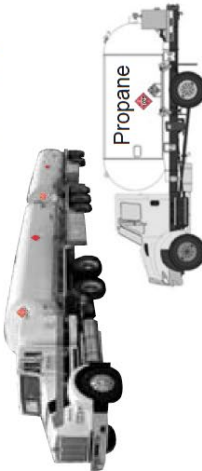

Federal Motor Carrier
Safety Administration



U.S. Department of Transportation
www.fmcsa.dot.gov

Commercial Driver's License (CDL)

COMMERCIAL MOTOR VEHICLE GROUPS

Group A (Combination Vehicle)

Any combination of vehicles with a gross combination weight rating (GCWR) of 26,001 pounds or more, provided the gross vehicle weight rating (GVWR) of the vehicle(s) being towed is in excess of 10,000 pounds.



Group B (Heavy Straight Vehicle)

Any single vehicle with a GVWR of 26,001 pounds or more, or any such vehicle towing a vehicle not in excess of 10,000 pounds GVWR.

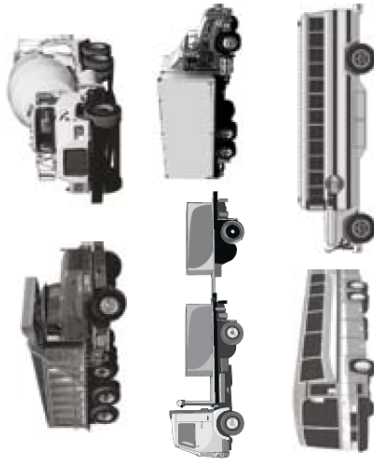

Group C (Small Vehicle)

Any single vehicle, or combination of vehicles, that meets neither the definition of Group A nor Group B, but is designed to transport 16 or more passengers including the driver, or is used in the transportation of materials found to be hazardous which require the motor vehicle to be placarded. This includes any quantity of chemical or biological material or agent posing a threat to national security, including toxins.



Revised 01/06

PROPERTY DAMAGE ESTIMATES

Item	Unit Measure	Estimated Cost
Attenuator / Crash Cushion		
Minor repair	Each	\$3,500
Complete replacement ≤45 MPH	Each	\$24,000
Complete replacement >45 MPH	Each	\$28,000
Bridge		
Cosmetic damage	Per Yard	\$4,000
Bridge damage - no exposed rebar	Per Yard	\$25,000
Bridge damage - exposed rebar	Per Yard	\$50,000
Cable Barrier		
Align and retention cable - per cable (Must be done if any post is damaged)	-	\$500
Cable replacement - per cable	Per Foot	\$50
Post	Each	\$250
Fence		
Section of chain link fence (Post to post)	Each	\$750
Section of wildlife fence (Post to post)	Each	\$1,000
Guard Rail / Barrier Wall		
Panel	Each	\$250
Post	Each	\$350
Guard rail start/end panel	Each	\$6,500
Concrete barrier wall	Per Yard	\$3,000
Signs		
Flashing pedestrian crossing sign	Each	\$9,500
Mile marker	Each	\$450
Single post – surface street	Each	\$450
Single post – highway	Each	\$3,000
Double post – small	Each	\$4,500
Double post - large	Each	\$15,000
Overhead sign – minor	Each	\$9,000
Overhead sign – major	Each	\$130,000
Wrong way detection sign and post	Each	\$20,000
Technology Infrastructure		
Roadway CCTV detection pole	Each	\$39,000
Traffic network cabinet	Each	\$17,000

PROPERTY DAMAGE ESTIMATES

Continued

Traffic Signal		
Control box (Minor repair)	Each	\$17,000
Control box (Replacement)	Each	\$65,000
Pedestrian signal post	Each	\$8,000
Traffic signal post	Each	\$15,000
Traffic signal mast arm	Each	\$95,000
Other		
Landscaping tree	Each	\$500
Light pole	Each	\$16,500
Movable concrete barrier	Each	\$3,000
Portable arrow board trailer	Each	\$13,000
Portable light tower trailer	Each	\$23,000
Portable message board trailer	Each	\$20,000
Portable speed measurement trailer	Each	\$10,000
Portable speed measurement and message trailer	Each	\$25,000
Railroad crossing arm	Each	\$2,000
Railroad crossing arm signal/controller	Each	\$9,000
Roadway asphalt repair	Per Yard	\$850
Traffic cone	Each	\$35
Traffic control barrel	Each	\$75
Traffic control delineator	Each	\$50

Large Double Post (Highway) Example:

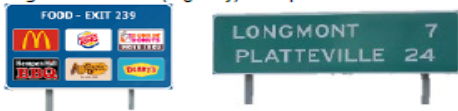

Small Double Post (Highway) Example:



FDOT Traffic Network Cabinets Example:



Wrong Way Detection Sign Example:









Traffic Control Delineator Example:









Attenuator/Crash Cushion Example:



BICYCLES AND OTHER PEDESTRIAN VEHICLES CHART

Vehicle						
Manufacturer Type	Bicycle	Electric Bicycle	Segway Hoverboard	Electric Unicycle	Motorized Scooter	Motorized Wheelchair
Chapter 316 Driving Definitions	Bicycle	Electric Bicycle	Electric Personal Assistive Mobility Device	Not defined	Motorized Scooter	Not defined
Classification Components in Chapter 316	Seat or Saddle	Pedals Seat or Saddle 750W or less motor	Designed for one person Two non-tandem wheels 750W or less motor	Not defined	No more than 3 wheels	Not defined
Propulsion	Human powered only	Human or Electric Powered Max speed 28 mph	Electric only Max speed 19 mph	Not defined	Gas or Electric Max speed 20 mph	Not defined
Helmet Requirements	Required for riders under age 16	Required for riders under age 16	Required for riders under age 16	Not defined	Required for riders under age 16	No
Operated on Public Roads	Yes	Yes	Yes, on roads where speed limit is 25 mph or less. May only cross roads with higher speed limit	Not defined	Yes	When necessary to avoid a potential conflict on a sidewalk
Operated on Bike Paths/Sidewalks	*Yes	*Yes	*Yes	Not defined	*Yes	Yes







BICYCLES AND OTHER PEDESTRIAN VEHICLES CHART

Vehicle						
Has the rights and duties of a . . .	Vehicle/Bicyclist/ Pedestrian depending on location on the roadway (defined in 316.2065)	See also bicycle	See also bicycle except for street use (see above)	Not defined	See also bicycle	Not defined (implied pedestrian)
Classified a Vehicle under Chapter 316?	Yes (not motor vehicle)	Yes (not motor vehicle)	No	Not defined	Yes (not motor vehicle)	Yes (not motor vehicle)
Driver License Requirement 322 Licensing	No	No	No	No	No	No
Chapter 319 - 320 Titling Requirements Chapter 320 Tags	No	No	No	No	No	No







Micromobility Device: motorized transportation device (including motorized scooters and electric bicycles) that can be rented through a website, online application, or software.

*Florida Statute 316.008 allows local authorities with jurisdiction over streets and highways to restrict and/or further regulate the use of vehicles, bicycles, electric bicycles, golf carts, mopeds, motorized scooters, skates, coasters, personal delivery devices, and mobile carriers. Local authorities may also regulate pedestrian crossings at unmarked crosswalks or at any locations outside of crosswalks.

MOTORCYCLES AND OTHER NON-TRADITIONAL VEHICLES CHART

Vehicle							
Manufacturer Type	Any motorcycle, Scooter or Trike over 50cc	Scooter (Speed over 20 mph and 50cc or less)	Moped (w/pedals) or Bicycle gas motor kit	Autocycle	Golf Cart	Go-Kart or Other small gas engine vehicles	All-Terrain vehicles (ATV) and Utility Vehicles
Chapter 316 Driving Definitions	Motorcycle	Motor vehicle	Moped	Motorcycle	Motor vehicle or golf cart	Motor vehicle	Off-highway vehicle (recreational use only)
Classification Components	More than 50cc; has seat or saddle and no more than three wheels in contact with the ground	Speed over 20 mph and 50cc or less	50cc or less; Cannot go more than 30 mph; gas bicycle classified as moped for registration/driving	2-wheel front, 1 rear; roll cage, seat belts, steering wheel, and seating that does not require operator to straddle	Max speed of 20 mph	Small gas engine vehicle	Any motorized off-highway or all-terrain vehicle, 3-4 nonhighway tires
Helmet Requirements	Required with exception*	Required only for passengers under 16 yoa	Required only for passengers under 16 yoa	Required with exception*	Not Required	Not Required	Under 16 yoa: Helmet, eye protection & boots Required
	<i>* Motorcycle Helmet Exception: 21 yoa or older with at least \$10,000 of medical insurance or riding in enclosed cab.</i>						
Eye Protection Requirements	Required	Not Required	Not Required	Required	Not Required	Not Required	Required if under 16 yoa

MOTORCYCLES AND OTHER NON-TRADITIONAL VEHICLES CHART

Vehicle							
Operated on Public Roads	Yes	Yes	Yes	Yes	Only on roads designated for golf carts with speed limit of 35 mph or less	No - Only on private property	No - Only on private property
Operated on Bike Paths/Sidewalks	No	No	Yes - if solely by human power only	No	No	No	No
Classified as a Motor Vehicle?	Yes	Yes	No	Yes	Yes	Yes	Yes
Driver License Requirement 322 Licensing	Class E operator with motorcycle endorsement or "motorcycle only" license	Class E operator; Must be 16 or older to operate or rent	Class E operator if 50cc or less; Must be 16 or older to operate or rent	Class E Operator	Class E operator only on roadways with speed limits of 35mph or less; None needed on private property or public recreational areas	None, not allowed on public roadways	None, not allowed on public roadways
Chapter 319 - 320 Titling Requirements Chapter 320 Tags	Title, tag and registration required; "Under 21" tag required if owner is under 21 yoa	Title, tag and registration required	Moped tag & registration required; Gas bicycle classified as moped for registration	Title, tag and registration required	Required if driven on roadways	No, cannot be registered; Use on private property only	Under 16 yoa to operate must have proof of completed ATV course & *adult supervision required

TRAFFIC SAFETY COALITIONS



www.flimpaireddriving.com



Motorcycle Safety Coalition
www.ridesmartflorida.com



www.floccupantprotection.com



Pedestrian & Bicycle Safety Coalition
www.alerttodayflorida.com



Safe Mobility for Life Coalition
www.safemobilityfl.com



www.flteensafedriver.org



Traffic Records Coordinating Committee
www.fltrafficrecords.com

AGING ROAD USER RESOURCES

Report Medically At-Risk Drivers through DAVID:

<https://david.flhsmv.gov>

- **Click** on Report Driver for Re-Exam button from the record detail page;
- **Check off** all medical conditions that apply; **and**
- **Provide** a brief description of any reason the driver is being reported.

This report is kept strictly confidential under Florida Law.

Contact an Aging and Disability Resource Center:

Statewide database of local community resources

1-800-96 ELDER (1-800-963-5337)

Law Enforcement Resource Page:

www.safemobilityfl.com/LawEnforcementResources.htm

Find Local Transportation Options:

www.findarideflorida.org

Order Florida's Guide for Aging Drivers:

Safe Mobility for Life Resource Center

(850) 644-8145

Email: safe-mobility-for-life@fsu.edu

Florida CarFit:

Educational community safety program

(855) 409-0200 (Toll Free)

www.car-fit.org

Elder Abuse Hotline:

1-800-96-ABUSE (1-800-962-2873)

<https://reportabuse.myflfamilies.com/s/>

WEBSITE / PHONE NUMBER RESOURCES

Florida Law Enforcement Liaison Program

www.floridalel.info

(850) 694-1130



Florida Department of Transportation

www.fdot.gov

(850) 414-4100



Florida Department of Highway Safety & Motor Vehicles

www.flhsmv.gov

(850) 617-2000



Florida Highway Patrol

www.flhsmv.gov/florida-highway-patrol/about-fhp

* FHP (* 347)



Florida Department of Law Enforcement

www.fdle.state.fl.us

850-410-7000



Florida Driver License Information

www.flhsmv.gov/html/dlnew.html

850-617-2000



Florida Department of Highway Safety and Motor Vehicles Uniform Traffic Citation Manual - Appendix C

http://www.flhsmv.gov/pdf/courts/utc/appendix_c.pdf

Florida Travel Information

<https://fl511.com/>



Traffic Safety Grant Funded Training

<https://www.fdot.gov/Safety/programs/lawenforcementgrants.shtm>



Road Ranger / Road Debris

www.fdot.gov/traffic/roadrangers

* FHP (* 347)



Sun Pass – Toll Violation / Toll Program

www.sunpass.com

1-888-865-5352





Distributed by the Florida Law Enforcement Liaison Program



Funded by:



Updated & Printed:
October 2024